

E.6

hex 22

High Performance

2 switching outputs

Electronic pressure switches, High-Performance series

hex 22 with two switching outputs



- Outstanding overpressure protection (up to 4 x)
- Ideal choice for mobile hydraulic applications
- Long service life even under high pressure change rates
- Wetted parts made of stainless steel and titanium ensuring excellent media compatibility
- All welded design, no elastomeric seal
- Silicon-on-sapphire technology (SoS) for highest reliability, accuracy and reliable process monitoring
- Very low temperature error and very good long-term stability
- Adjustment of switching point and hysteresis at factory

For versions with 1 switching output,
please refer to chapter E.5, page 122

Electronic pressure switches, High-Performance series

Technical details

	0540 NO / NO 0541 NC / NC 0542 NO / NC			0544 NO / NO 0545 NC / NC 0546 NO / NC	
Number of transistor outputs:	2 PNP outputs (High Side N-channel MOSFET)			2 NPN outputs (Low Side N-channel MOSFET)	
Supply voltage:	9.6 - 32 VDC				
Idle power consumption:	< 15mA				
Standard adjustment range p_{nom} :	0 – 10 bar	0 – 25 bar	0 – 100 bar	0 – 250 bar	0 – 600 bar
Overpressure protection p_u ¹⁾ :	40 bar	100 bar	400 bar	1,000 bar	1,650 bar
Burst pressure ¹⁾ :	80 bar	200 bar	800 bar	2,000 bar	2,000 bar
Mechanical life expectancy:	10,000,000 switching cycles at rise rates to 5,000 bar/s at p_{nom}				
Permitted pressure change rate:	≤ 5,000 bar/s				
Switching point adjustment range:	2 ... 100 % of the nominal pressure range (Full Scale, FS), programmable at factory				
Hysteresis:	0.2 ... 99.8 % of the nominal pressure range (FS), programmable at factory (set to 5% FS as standard)				
Accuracy:	±0.5 % of the nominal pressure range (FS) at room temperature, ±0.25 % BFSL				
Resolution:	0.1 % of the nominal pressure range (FS)				
Switching delay:	ON (0 ... 0.5 s) / OFF (0 ... 2 s) delay in increments of 1 ms, irrespective of switching point, programmable at factory (specify value when Ordering, otherwise default value of 0 s is set)				
Output:	0.5 A transistor output with short-circuit and overvoltage protection				
Operating mode:	with hysteresis or window function (see page 101), programmable at factory				
Long term stability:	±0.1 % FS p. a.				
Repeatability ²⁾ :	±0.1 % FS				
Temperature error ²⁾ :	±0.02 % / 1 K FS				
Compensated temperature range:	-20 °C ... +80 °C (-4 °F ... +176 °F)				
Temperature range media:	-40 °C ... +125 °C (-40 °F ... +257 °F)				
Temperature range ambient:	-40 °C ... +100 °C (-40 °F ... +212 °F)				
Wetted parts material:	Stainless steel 1.4305 (AISI 303) and titanium				
Housing material:	Stainless steel 1.4305 (AISI 303)				
Insulation resistance:	> 100 MΩ (35 VDC)				
Switching time:	< 2 ms				
Vibration resistance:	20 g at 4 ... 2000 Hz sine wave; DIN EN 60068-2-6				
Shock resistance:	half sine wave 500 m/s ² ; 11 ms; DIN EN 60068-2-27				
Protection class:	Refer to the electrical connections				
EMC:	EMC 2014/30/EU, EN 61000-6-2:2005, EN 61000-6-3:2007				
Protection against reverse polarity, short-circuit and over voltage surges:	built-in				
Weight:	approx. 80 g (DIN 175301 approx. 110 g, cable version approx. 135 g)				

¹⁾ Within the compensated temperature range.

²⁾ Static pressure, dynamic value is 30 to 50 % lower. Values refer to the hydraulic/pneumatic part of the electronic pressure switch.



E.6

hex 22

High Performance

2 switching outputs

0540 / 0541 / 0542 / 0544 / 0545 / 0546

Electrical connectors and threads



Connection diagrams

High Side Output (PNP)

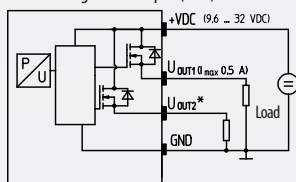

Pin assignment depending on electrical connections
* U_{out2} only for 054x

Low-Side Output (NPN)

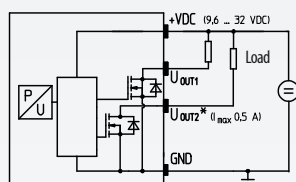

Pin assignment depending on electrical connections
* U_{out2} only for 054x

Technical modifications and errors excepted.



M12 – DIN EN 61076 - 2 - 101 A

Pin	Assignment
1	U_{V+}
2	U_{Out2}
3	Gnd
4	U_{Out1}

IP67
x ~ 54 mm
d ~ Ø 22 mm
Connection code: 002

ISO 15170 - A1 - 4.1

Pin	Assignment
1	U_{V+}
2	Gnd
3	U_{Out1}
4	U_{Out2}

IP67, IP6K9K
x ~ 65 mm
d ~ Ø 27 mm
Connection code: 004

Deutsch DT04 - 4P

Pin	Assignment
1	Gnd
2	U_{V+}
3	U_{Out2}
4	U_{Out1}

IP67, IP6K9K
x ~ 74 mm
d ~ Ø 23 mm
Connection code: 008

Cable connection

Pin	Assignment
red	U_{V+}
white	U_{Out2}
black	U_{Out1}
blue	Gnd

IP67
x ~ 44 mm (+ 20 mm bend relief)
Cable length ~ 2 m
d ~ Ø 22 mm
Connection code: 011

Thread code: 41

Thread code: 03

Thread code: 04

Thread code: 09

Thread code: 30

Thread code: 20

Thread code: 21

Thread code: 42

0540 / 0541 / 0542 / 0544 / 0545 / 0546

Article matrix for electronic pressure switches

E.6

hex 22

High Performance

2 switching outputs



	Type	Adjustment range	Pressure connection	Pressure unit	Electrical connection
--	------	------------------	---------------------	---------------	-----------------------

Type					
PNP output (High Side), NO / NO	0540				
PNP output (High Side), NC / NC	0541				
PNP output (High Side), NO / NC	0542				
NPN output (Low Side), NO / NO	0544				
NPN output (Low Side), NC / NC	0545				
NPN output (Low Side), NO / NC	0546				

Max. Overpressure ²⁾	Burst pressure	Adjustment range ¹⁾	
40 bar	80 bar	0 - 10 bar (approx. 145 PSI)	101
100 bar	200 bar	0 - 25 bar (approx. 362 PSI)	251
400 bar	800 bar	0 - 100 bar (approx. 1.450 PSI)	102
1,000 bar	2,000 bar	0 - 250 bar (approx. 3.620 PSI)	252
1,650 bar	2,000 bar	0 - 600 bar (approx. 8.700 PSI)	602

Pressure connection	
G 1/4 – DIN EN ISO 1179-2 (DIN 3852-11), form E	41
G 1/4 – DIN 3852-A	03
NPT 1/8 (max. 250 bar)	04
NPT 1/4	09
M10x1 zyl. DIN 3852-A (max. 250 bar)	30
7/16 – 20 UNF (max. 250 bar)	20
9/16 – 18 UNF	21
M14x1,5 – DIN EN ISO 9974-2 (DIN 3852-11), form E	42

Pressure unit	
bar	B

Electrical connection	
M12x1 - DIN EN 61076-2-101-A	002
Bayonet ISO 15170-A1-4.1 (DIN 72585-A1-4.1)	004
Deutsch DT04-3P	008
Cable connection (length of cable 2 m standard)	011

Article number	054X	XXX	XX	B	XXX
----------------	------	-----	----	---	-----

¹⁾Please state switching point and hysteresis when ordering.

²⁾ Static pressure, dynamic pressure 30 to 50% lower. Values refer to the hydraulic or pneumatic part of the electronic pressure switch.



General technical explanations

User information

Our pressure monitoring products may only be installed and started up by authorised specialists. The safety regulations of country-specific authorities must be observed, especially when working with mains voltages and oxygen, and in potentially explosive areas.

Product information

The technical information in this catalogue is based upon fundamental testing during product development and empirical values. The information cannot be used for all application scenarios.

Testing of the suitability of our products for a specific application (such as the checking of material compatibilities) remains the responsibility of the user. It may be the case that suitability can only be verified by appropriate field testing.

Mounting position

For mechanical and electronic pressure switches as well as transmitters there is no limitation due to the mounting position with regard to the accuracy of the pressure measurement.

However, other boundary conditions of the application may require a certain mounting position, e. g. horizontal installation to avoid waterlogging on the electrical connection or vertical installation to prevent debris from accumulating in the bore of the pressure connection.

IP protection class

The IP protection class is a defined protection level code (sealing) of electrical equipment housings in line with IEC 60529 (formerly DIN 40050 – Part 2). Protection of a housing against the following is tested here:

- The penetration of solid extraneous particles, such as dust
- Access of hazardous parts
- Penetration of water

IP protection tests are performed as type tests.

The IP protection type code, made up of two digits, specifies the protection of a housing against the penetration of solid extraneous particles and water.

The numeric code therefore provides conclusions to be drawn on the level of personal safety as well as the functional protection / mid to longterm functional reliability of electrical equipment.

Protection types IP00, IP65, IP67 and IP6K9K

IP00:

No protection against penetration of solid particles or water, no protection against contact.

IP6X:

Protection against penetration of dust (dust proof). Full contact protection.

IPX5:

A jet of water from a nozzle, aimed at equipment (such as a pressure switch) from all directions, must not have any harmful effect.

IPX7:

Protection from water, when equipment (such as a pressure switch) is immersed in water under defined pressure and time conditions. Water must not penetrate into the equipment in harmful quantities.

IP6K9K:

Devices satisfying these requirements must be dust-proof and be able to withstand loads during the use of high-pressure cleaners and steam jets. The standard stipulates a water pressure from 80 to 100 bar at a temperature of 80 °C for testing.

IP6KX:

Dust must not penetrate. Letter K: Specific to the electrical equipment of road vehicles.

IPX9K:

Protection against penetration of water at high pressure / for steam jet cleaning. Water aimed at the housing from every direction at greatly increased pressure may not have any damaging effects.

We are able to offer IP67 / IP6K9K for many of our mechanical and electronic pressure switches (pre-wired or with integrated connector) and for our transmitters.

IP67 / IP6K9K is the recommended protection for mobile hydraulics and any equipment exposed to the outdoor environment.

Cylindrical threads

Cylindrical threads are either sealed on the front by underlaying an appropriate sealing ring (such as a copper sealing ring) or by already having integrated O-rings or gaskets.

If the corresponding thread types do not provide specifications regarding the roughness of the counter sealing surface, we recommend the following values:

$$R_{\text{amax}} 1.6 \mid R_{\text{max}} 6.3 \mid R_{\text{mr}} (-0.10) > 5\% C_{\text{ref}} 5\%$$

Conical threads (cone-shaped threads)

Conical threads guarantee tolerance compensation of the two threaded parts. The sealing function is realised with thread flanks which deform permanently and enter into a metallic frictional fit. Conical threads are not screwed in down to the screw-in depth, but fixed with the tightening torque required for the leak tightness.

Remember not to exceed the permitted tightening torque of the pressure switch or transmitter presented in the following table (to prevent damaging the threaded pin beforehand, causing it to become untight during operation or to snap off when tightened).

Tightening torques of steel threads

The specifications below are to be understood upper material thresholds for the housing of pressure switches or transmitters. Remember during installation that the type and material of the seal, the condition of mating surfaces (e.g. dry or oily) and the material of the counter-piece all have a bearing on the tightening torque.

Threads M10, G 1/8, R 1/8 and NPT 1/8 are limited to overpressure strengths of up to 600 bar.

Values 30% lower than in the following table must be used for brass housings.

Thread	Tightening torque
NPT 1/8; M 10 x 1 conical	max. 18 Nm
M 10 x 1 cyl.; G 1/8	max. 20 Nm
M 12 x 1.5; 7/16 – 20 UNF	max. 30 Nm
G 1/4; 9/16 – 18 UNF	max. 40 Nm
NPT 1/4; M 14 x 1.5	max. 40 Nm

Gaseous applications

In particular using additional sealant to attain the required leak tightness may be necessary for gas applications.

Plasma cleaning for oxygen applications

When pressure switches/transmitters are used with oxygen, the surfaces must be free of oil and grease residues to prevent spontaneous combustion. Special requirements must also be observed for oxygen applications with regard to the material selection of housings and seals as well as the permitted operating pressure (see also page 17). We would be pleased to advise you if necessary.

For these operating conditions, we offer plasma cleaning of the components in order to achieve the required elimination of oil and grease. The components are packed and sealed in plastic bags. The packaging is marked with safety instructions for use in oxygen applications.

Plasma cleaning LABS-free (PWIS-free)

Our products are always manufactured without the use of substances that interfere with the wetting of the paint throughout the entire manufacturing process. For use in LABS-free applications, we offer plasma cleaning of the components. The components are packed and sealed in plastic bags. The packaging is marked with safety instructions for use in LABS applications.

Vacuum

The values given in the technical details for the vacuum range are specified in millibars (mbar) below atmospheric pressure.

Pressure change rate (~rise / ~fall)

The pressure change rate denotes the pressure over time for the rising/falling pressure. It is specified in bar/s.

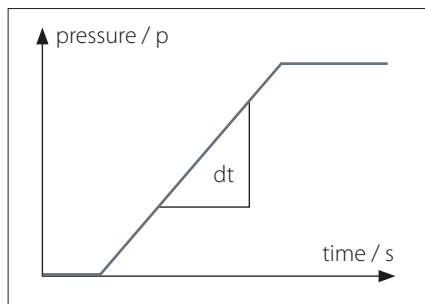

The maximum pressure change rate for mechanical pressure switches is 1,000 bar/s. For SUICO electronic pressure monitoring products the maximum pressure change rate can be up to 5,000 bar/s.

Overpressure protection

The specified overpressure protection in the catalogue is based on a static pressure. The values refer to the hydraulic or pneumatic part of the switch.

It is best practice to use 30 - 50% lower values for dynamic pressure compared to static pressure. These empirical values are based on the knowledge that, in pressure systems, unexpected pressure peaks which are higher than the working pressure are generated as a result of activation of valves, sudden falling or rising load or simply the change of cross-sections in the pipes. With conventional measurement techniques (such as manometers), these pressure peaks are hardly measurable. Faster measurement systems must therefore be used for this data acquisition. Attempts are being made to take this into account by using empirical or corrective factors.

If the pressure conditions are known and the pressure change rates are 100 bar/s, our pressure switches and transmitters can be used up to the permitted overpressure protection as per data sheet / catalogue. Only 50 % of the specified overpressure protection is permitted when operating at the maximum permitted pressure change rate of $\leq 1,000$ bar/s for mechanical pressure switches, and at $\leq 5,000$ bar/s for transmitters.

RoHS-Compliance

= Restriction of Hazardous Substances (EC Directive 2011/65/EU)



CE-Mark

= Communauté Européenne



European Parliament and Council directives must be observed when products are launched onto the market. If a directive exists for a product, it must be applied. Only products for which a directive exists may bear the CE mark.

Only products which have been tested according to CE directive or corresponding standards may carry the CE mark.

Mechanical pressure switches with a supply voltage above 50 VAC or 75 VDC are covered by the 2014/35/EU Low Voltage Directive. Variants for potentially explosive areas are covered in addition by the 2014/34/EU ATEX Product Directive.

Our electronic products satisfy EMC (Electromagnetic Compatibility) Directive 2014/30/EC. Mechanical pressure switches do not fall under the EMC Directive.

The Machinery Directive 2006/42/EC is not applicable, because our products are classed as components.

Our product designs are based upon „good engineering practise“ in line with Article 4, Paragraph 3 of the Pressure Equipment Directive (2014/68/EU), meaning neither a declaration of conformity may be issued nor a CE mark affixed.

The current product-specific CE declaration is available in the download area of our homepage:

www.suco.de/en/downloads

Subject to technical changes

Technical explanations for electronic pressure switches

What is an electronic pressure switch?

An electronic pressure switch converts the medium pressure which is present at the measuring cell into a digital, electrical switch signal (ON / OFF).

An electronic pressure switch is more complex than a mechanical pressure switch, and thus generally more expensive. As an electronic pressure switch has no moving parts (relative to each other), it usually has a much prolonged service life and provides a higher level of precision (depending on application).

The hysteresis can be set over a wide range and virtually independently of the switching point. Electronic pressure switches can also be equipped with additional functions, such as optical displays and menu control.

How does an electronic pressure switch work?

The pressure measuring cell fitted (1) has a membrane that is exposed to the pressure to be measured. Affixed to this membrane is a bridge circuit consisting of four ohmic resistors in the form of a Wheatstone bridge. The values of these resistors change proportionally to the pressure load present at the measuring cell or membrane. The bridge voltage of the measuring cell is amplified in the evaluation electronics (2) and processed digitally by a microcontroller (3).

Once the switching point or switch-back point is reached, the output transistor (4) closes or opens depending on the output function (normally open / closed contact).

„Oil-filled“ stainless steel measuring cell

In this measuring cell technology, the piezoresistive measuring cell is packaged within a metallic housing filled with fluorine oil. This means the measuring cell is virtually free of external mechanical stress. Fluorine oil has excellent characteristics in regards to temperature and ageing behaviour, and is not flammable and so fits perfectly for oxygen applications. It is not recommended for food applications.

Ceramic measuring cell / thick film technology

Ceramic thick film pressure measuring cells are made up of a sintered ceramic body. The ceramic body sleeve already has the key geometries for the subsequent pressure range. The membrane thickness required and thus, the pressure range required is established with grinding and lapping. The resistors are imprinted with thick film technology and interconnect to form a measuring bridge.

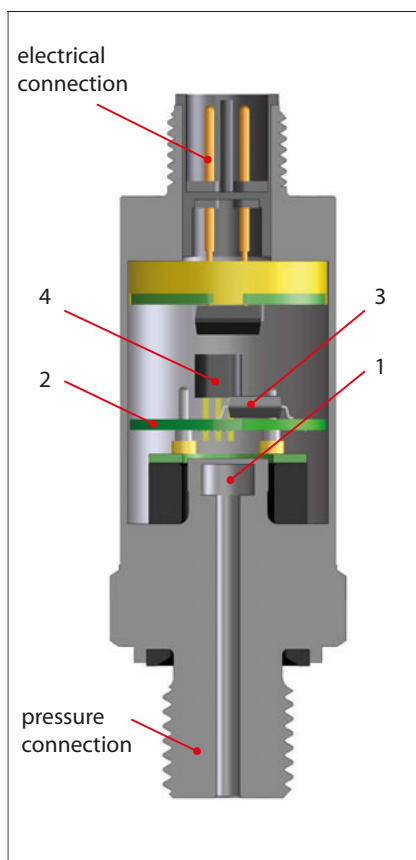

SoS technology

In the silicone-on-sapphire technology, the substrate of the thin film measuring cell is synthetic sapphire. This has excellent mechanical and temperature stable properties and prevents undesired parasitic effects, thereby having a positive effect on accuracy and stability. In conjunction with a titanium membrane, this results in virtually unique coaction between the temperature coefficients of sapphire and titanium.

This is because, unlike silicon and stainless steel, they are more closely matched and thus require only a low level of compensation. This also has a favourable effect on longterm stability.

Block diagram

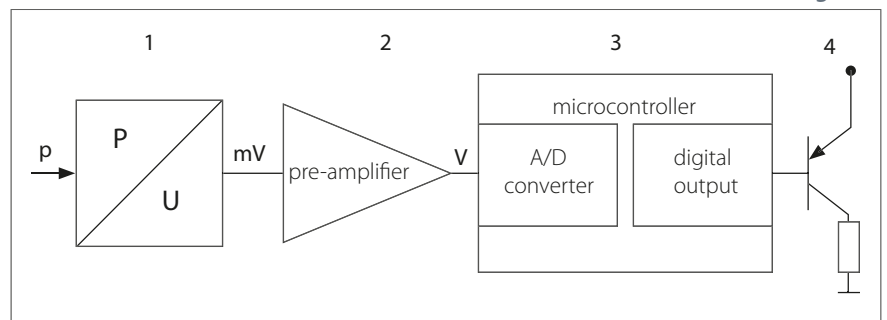

Adjustment range of switching point

The pressure range within which the switching point of an electronic pressure switch can be set is called adjustment range. The switching point corresponds to the pressure value at which the electric circuit of the output is opened or closed.

Switching point accuracy and tolerances

The switching point accuracy of electronic pressure switches is specified by SUCO and relates to the full scale value (FS).

The switching point tolerances specified by us are valid at room temperature (RT) and new state. The values can change as a result of temperature, ageing and application specific conditions. Switching points can either be set at the factory or by the customer on site (depending on model).

Hysteresis

Rising/falling switching point

The difference between the rising (upper) and falling (lower) switching points (refer to the figure) is known as hysteresis (switchback difference).

Our electronic pressure switches are a perfect fit to extremely low or high hysteresis.

Hysteresis is either set at the factory or by the customer on site (only the 0570 series). The hysteresis or switch-back point of all pressure switches can be set over almost the entire adjustment range.

Please ask about the possible setting ranges you may require.

The hysteresis specified in the data sheet is set if nothing is specified in the order.

Window function

In the window function, the switch signal is programmed such that it remains ON or OFF between two values. This means a defined pressure range can be monitored. This function is only possible on the 053X series.

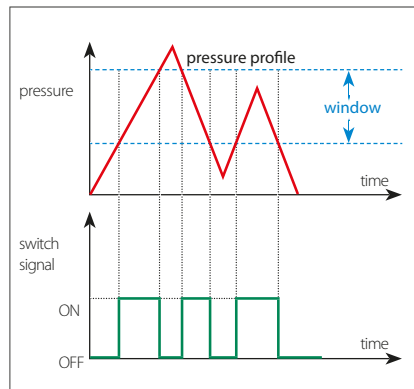

Switching delay

Switch outputs can be programmed with a delay separately for switch-on and switch-off (depending on model). Delays of up to several seconds are possible.

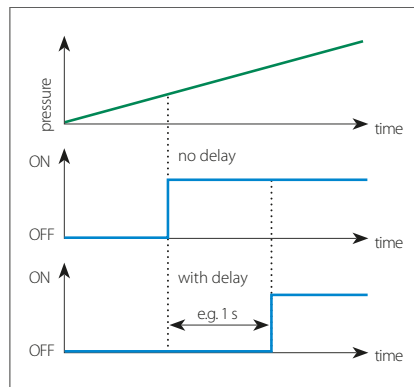

Hysteresis

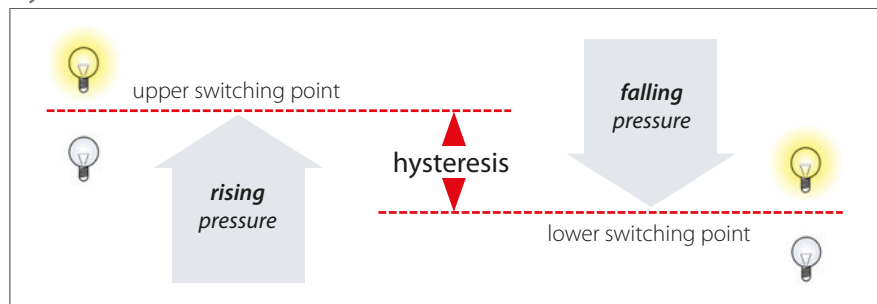

Operating/supply voltage

All electronic pressure switches work with DC voltage and have no galvanic isolation. Within the thresholds specified in the relevant data sheet, the supply voltage may change without influencing the output signal. In order to guarantee the functionality of an electronic pressure switch, the minimum operating voltage must be respected. The maximum operating voltage may not be exceeded to avoid damage on the electronics.

Output current

Depending on the model, electronic pressure switches have a maximum output current of 0.5 A to 1.4 A and therefore are also suitable for applications requiring relatively high control and switching currents.

Load

The output transistor is an open collector, i.e. the output must be wired with a load. The load limits the switching current and is selected according to the application.

Electronic pressure switches have protection from voltage peaks at the output, and are short-circuit proof. When inductive loads are switched (relays, motors, etc.), provision may have to be made for an additional electronic snubber to eliminate high voltage peaks. This is realised e.g. with flyback diodes, or even better with suppressor diodes or varistors.



Technical explanations for electronic pressure switches

Connection types and output functions

There are essentially two different ways to connect the load or apparent ohmic resistance to electronic pressure switches:

PNP output / high-side / plus-switching

PNP output (plus-switching) is the most popular variant in Europe. Here the load is connected to the output of the switch and ground (GND as reference potential).

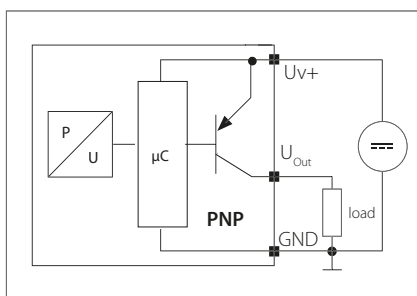

NPN output / low-side / minus-switching

For an NPN output (minus-switching), the load is connected to the switching output and to the positive line of the supply voltage (Uv+ as reference potential).

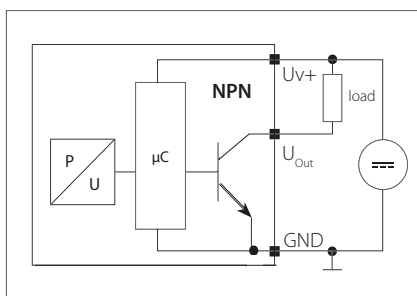

NO / NC

Electronic pressure switches are available as normally open (NO) or normally closed (NC) versions. Also refer to section M.0, page 14.

Temperature errors and ranges

The temperature (both of the medium and environment) generally has a significant influence on the accuracy of an electronic pressure switch. Electronic pressure switches are temperature compensated over a particular range corresponding to the typical application. This means that temperature errors within this temperature range are minimised by means of circuitry design and algorithms. The temperature error is added to the accuracy, and shown in the total error band of the electronic pressure switch, also called „butterfly graph“. Outside the compensated temperature range, the maximum error is not defined, however the electronic pressure switch still functions. To prevent mechanical and electrical damage, electronic pressure switches may not be used beyond the threshold temperature ranges specified in the data sheet.

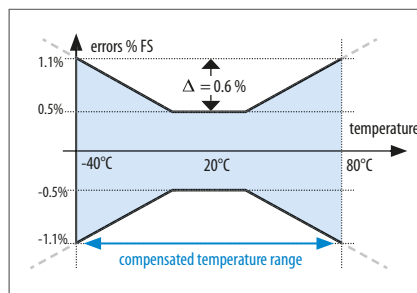

Service life and long-term stability

Service life information pertains to nominal conditions specified in the data sheet, and can vary considerably when a product is operated mechanically or electrically outside the specifications. Service life essentially depends on the used measuring cell technology.

Ageing is accelerated (or slowed) due to different factors - such as temperature, temperature change and reduction of mechanical forces. The occurrence of ageing does effect the total accuracy.

SUCO specifies long-term stability in accordance with DIN 16086 in relation to one year. Typically the influence of aging on the accuracy reduces with increasing operating duration. The information in the data sheet corresponds to the worst case scenario.

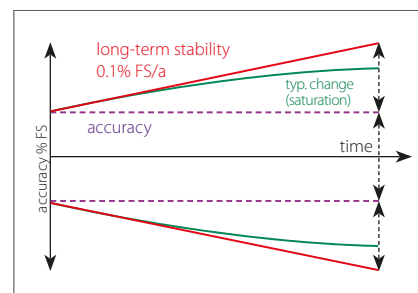

Resolution

The A/D resolution (analogue - digital) of an electronic pressure switch defines the smallest change of the analogue - digital - analogue conversion which takes place by the signal processing of an electronic pressure switch. If for example 13-bit resolution is used for an electronic pressure switch with a 100 bar setting range, the smallest signal change is 8192 steps (2^{13}). As state of the art a resolution of 12 bits and hence 4096 steps (2^{12}) is typical. Therefore pressure changes of $100 \text{ bar} / 4096 = 0.024 \text{ bar}$ can be recorded.

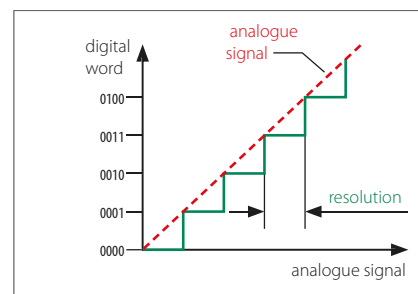

Sampling rate

The sampling rate (or sampling frequency) defines the number of samples per time unit (typically in seconds or milliseconds) taken from an analogue signal and converted to a digital signal. The sampling rate is an indicator of how fast the output signal of an electronic pressure switch responds to the pressure change at the input.

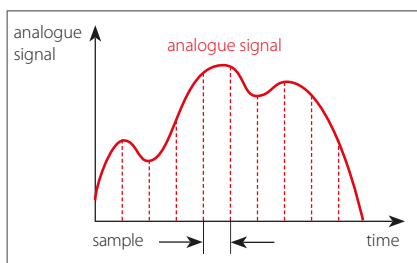

Response time

The response or circuit time is shorter than 2 to 4 milliseconds (depending on model). The sum of A/D and D/A conversions, and the analogue and digital filters in the signal chain from the measuring bridge to the output, make up the response time. Filtering is used to suppress unwanted pressure peaks and electrical interference signals and to ensure good EMC characteristics.

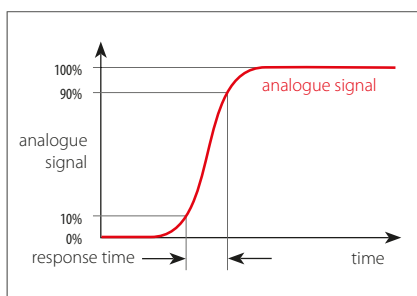

CE mark

Electronic pressure switches from SUCO fall under the 2014/30/EU EMC Directive. EC declarations of conformity have been issued for the electronic pressure switches are available on request or can be downloaded from our website. The relevant devices are denoted by a CE mark in our catalogue.

The Machinery Directive 2006/42/EC is not applicable, because our products are classed as components.

Our products are designed for Group 2 fluids based upon good engineering practise in line with Pressure Equipment Directive 2014/68/EU, meaning neither a declaration of conformation may be issued nor a CE mark affixed.

Electromagnetic compatibility (EMC)

Electronic pressure switches from SUCO do comply to all important industrial EMC standards. The basis for the standards are the stricter thresholds for transient emissions in residential environments (EN 61000-6-3) and immunity for industrial environments (EN 61000-6-2).

Generic standard	Test standard	Parameter(s)
Radio disturbance and immunity	EN 55016-2-1 EN 55016-2-3	60 dBuV
Radiated, high-frequency electromagnetic field immunity test	EN 61000-4-3	10 V/m; 80-1000 MHz, 3 V/m; 1400-2000 MHz, 1 V/m; 2000-2700 MHz
Immunity to conducted disturbances, induced by radio-frequency fields	EN 61000-4-6	10 V; 0,15-80 MHz
Electrical fast transient / burst immunity test	EN 61000-4-4	±2 kV
Surge immunity test	EN 61000-4-5	±0.5 kV (common) ±0.5 kV (differential)
Electrostatic discharge (ESD) immunity test	EN 61000-4-2	air: 8 kV with contact: 4 kV



Technical explanations for electronic pressure switches

Conversion chart for pressure units

Abbreviation for unit	Name of unit	Pa = N/m ²	bar	Torr	lbf/in ² , PSI
1 Pa = N/m ²	Pascal	1	0.00001	0.0075	0.00014
1 bar	Bar	100 000	1	750.062	14.5
1 Torr = 1 mmHg	Millimeters of mercury	133.322	0.00133	1	0.01934
1 lbf/in ² = 1 PSI	Pound-force per square inch	6894	0.06894	51.71	1

Conversion chart for temperature units

	K	°C	F
K	1	K - 273.15	9/5 K - 459.67
°C	°C + 273.15	1	9/5 °C + 32
F	5/9 (F + 459.67)	5/9 (F - 32)	1

Insulation strength

According to the latest specifications for immunity to surges and lightning protection, the following must be taken into account when testing insulation strength: With insulation test devices having an inner resistance exceeding 42 Ohm, the insulation strength of electronic pressure switches can be tested up to 500 VDC.

All contacts must be tested short-circuited against the housing. For a specific threshold value of test voltage, the protective circuit for surge protection is activated without any defects arising within the circuit.

In the process, the current may rise to a point at which an insulation strength fault is indicated. The recommendation therefore is to conduct the insulation test of the electronic pressure switch when it is removed, or independently of the overall system.

Medium compatibility

The specifications on medium compatibility in this catalogue pertain to the specific seal and housing materials as well as the used measuring cell technology and so cannot be generalised.

Titanium

Its high levels of mechanical resistance and the wide media compatibility – in particular to corrosive media – do make titanium the ideal material for measuring cells and membranes. It is not recommended for oxygen or hydrogen applications.

Stainless steel (1.4305 / AISI 303)

Stainless steel with broad level of media compatibility. Also suitable for oxygen and hydrogen applications.

Stainless steel (1.4404 / AISI 316L)

Stainless steel with broad level of media compatibility. Also suitable for chemical industry and sea water applications.

Oxygen and hydrogen

It is recommended to use an EPDM seal for the media oxygen / hydrogen to be monitored. The EPDM seal of the „Performance“ series (pp. 106-113) was successfully tested at the BAM (Federal Institute for Materials Testing) up to 250 bar by means of an oxygen pressure shock test at 60 °C.

EPDM must not come into contact with oil, as this results in swelling and softening of the material and thus the failure of the electronic pressure switch.

Country-specific safety requirements and application guidelines must be observed if the medium to be monitored is oxygen or hydrogen, such as DGUV accident prevention regulations (DGUV 500, Section 2.32 and BGI 617).

Please specify when ordering „for oxygen, oil and grease-free“ or order plasma cleaned and individually packaged electronic pressure switches (see also „Plasma cleaning for oxygen applications / LABS-free (PWIS-free)“ on page 9).

Pressure peak dampening

If required, our electronic pressure switches can also be fitted with a pressure snubber (pressure peak orifice) to protect the measuring cell against transient pressure loads such as pressure peaks due to the switching of valves, cavitation effects, etc. which can shorten life expectancy.

For liquid media, the hole of a pressure snubber cannot be chosen to be any small size. At low temperatures the viscosity of the media will increase. In a case of dropping pressure the media might remain in the cavity behind the snubber which might affect the functionality of the electronic pressure switch. Thus a bore diameter of 0.8 mm has been established.

Product information

The technical information in this catalogue is based upon fundamental testing during product development, as well as upon empirical values. The information cannot be used for all application scenarios.

Testing of the suitability of our products for a specific application (e.g. also the checking of material compatibilities) falls under the responsibility of the user. It may be the case that suitability can only be guaranteed with appropriate field testing.

Subject to technical changes.